



99-CURRENT FORD SUPER DUTY STD. CAB

IN07A 04/15/04

YOUR BRACKETS INSTALL IN FACTORY HOLES

QTY.	DESCRIPTION	QTY.	DESCRIPTION
1	RUNNING BOARD 1 DRIVER & 1 PASSENGER	4	HORIZONTAL BRACKET, SUPPORT, 3124F
1	STONE GUARD 2 LEFT & 2 RIGHT	4	5/16" CLIP NUT
8	3/8"x1 SELF TAPPING SCREW	20	5/16"x 3/4" BOLT
8	#14x3/4" TEK SCREW	18	5/16"-18 HEX NUT
8	1/4x5/8" SQUARE HEAD SCREW	4	FLAT BRACKET, FL11
8	1/4-20 HEX NUT	1	END CAP 1 LEFT & 1 RIGHT

TOOLS REQUIRED: 5/16" DRILL • 1/2" HEX SOCKET • 1/2" WRENCH • 5/16" NUT DRIVER • 3/8" NUT DRIVER

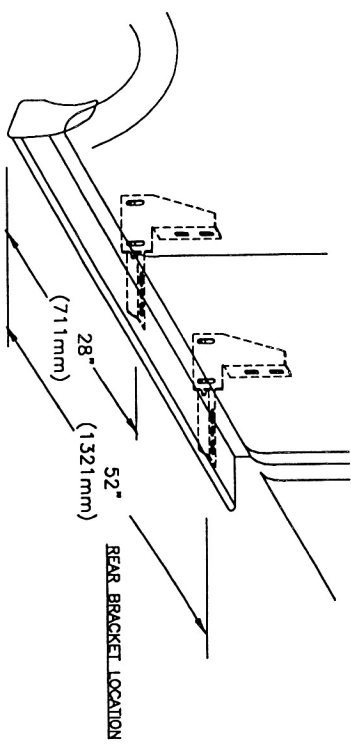

① (DRIVERS SIDE SHOWN)
MEASURE FROM FRONT WHEEL WELL TO BRACKET LOCATION
MARK THIS DIMENSION ON THE PINCH WELD

② BRACKET ASSEMBLY
ASSEMBLE WITH 5/16" BOLTS

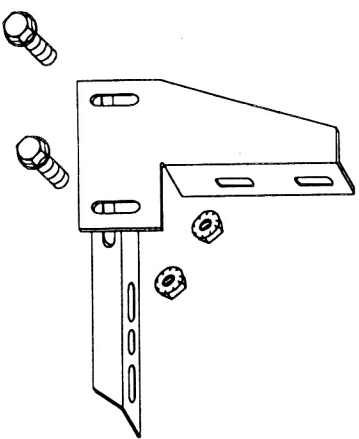

③ SLIDE CLIP NUT INTO BODY
HOLES AT BRACKET LOCATIONS

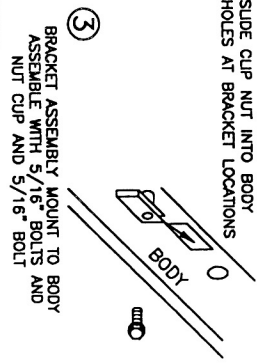

④ MOUNT AT LOCATION SHOWN AT ①

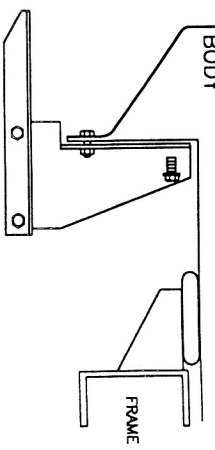

④ BEND STONE GUARD BY HAND AND
KNEE TO FIT THE WHEEL WELL
BEFORE INSTALLING TO RUNNING BOARD

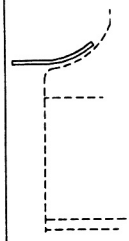

⑤ FASTEN FRONT STONE GUARD
TO BOARDS WITH 3/8" SELF
TAPPING BOLT. BEND STONE
GUARD BY HAND AND KNEE
TO FIT THE WHEEL WELL

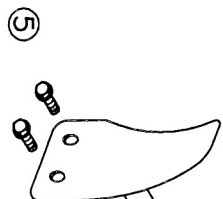

⑦ INSTALL END CAP TO BOARD
WITH 3/8" SELF TAPPING BOLT

⑥ SLIDE TWO 1/4"x5/8"
SQUARE HEAD SCREWS
INTO EACH TRACK.

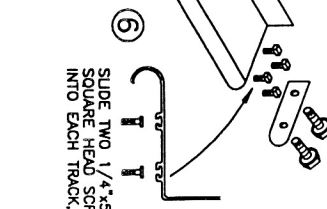

⑧ HOLD BOARD IN PLACE WITH THE
REAR RESTING ON THE BACK BRACKET

③ PLACES AT EACH STONE GUARD

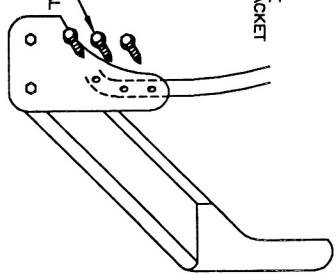

NOTE: BE SURE THAT 1/4" BOLTS ARE PLACED
INTO THE BRACKET STEP SUPPORT

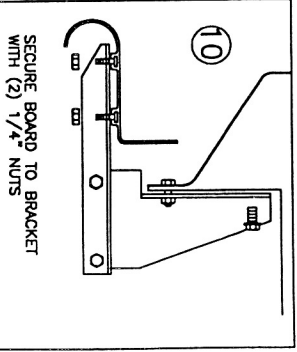

⑪ WITH BOARD LEVEL, TIGHTEN
ALL LOOSE BOLTS

⑫ REPEAT FOR OTHER SIDE

IN07A 04/15/04
OWENS PRODUCTS+1000 PROGRESS STREET+STURGIS, MI 49091+616-651-2300+TOLL-FREE: 800-726-8367+FAK618-651-8326+WEB:www.owens-pro.com